

Item:

LHCD-20/25/30W-5CCT
 LHCD-32/42/55W-35K
 LHCD-4-HZ/WH
 LHCD-6-HZ/WH
 LHCD-8-HZ/WH
 LHCD-10-HZ/WH

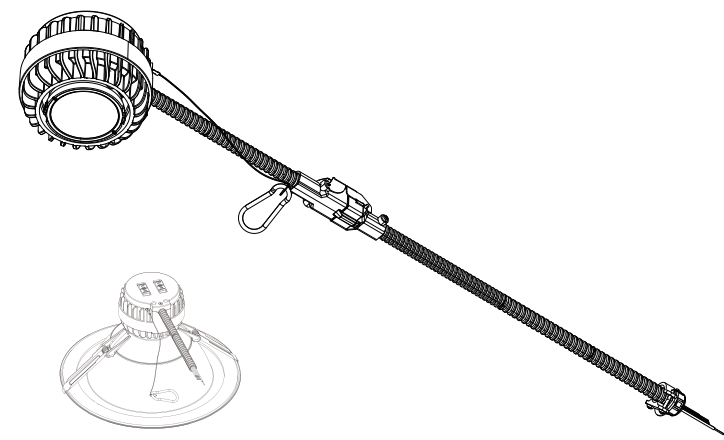

Light module & reflector module style design



1

SAFETY INSTRUCTION

Please read and understand this entire manual before attempting to assemble, operate or install the product.

WARNING - RISK OF FIRE OR ELECTRIC SHOCK. INSTALLATION OF THIS RETROFIT KIT REQUIRES A PERSON FAMILIAR WITH THE CONSTRUCTION AND OPERATION OF THE LUMINAIRE'S ELECTRICAL SYSTEM AND THE HAZARD INVOLVED. IF NOT QUALIFIED, DO NOT ATTEMPT INSTALLATION. CONTACT A QUALIFIED ELECTRICIAN. AVERTISSEMENT - RISQUE D'INCENDIE OU DE CHOC ÉLECTRIQUE. L'INSTALLATION DE CE DO NOT MAKE OR ALTER ANY OPEN HOLES IN AN ENCLOSURE OF WIRING OR ELECTRICAL COMPONENTS DURING KIT INSTALLATION.

TOOLS REQUIRED (Not Included)(Cont.)

NOTE: Keep your receipt and these instructions for Proof of Purchase.

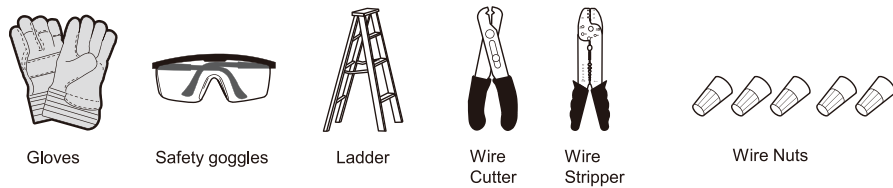

Changes or modifications to this unit not approved by the party responsible for compliance could void the user's authority to operate the equipment.

NOTE: This equipment has been tested and found to comply with the limits for a Class B digital device, to Part 15 of the FCC Rules. These limits are designed to provide reasonable protection against harmful interference in a residential installation. This equipment generates, uses and can radiate radio frequency energy and if not installed and used in accordance with the instructions, may cause harmful interference to radio communications. However, there is no guarantee that interference will not occur in a particular installation. If this equipment does cause harmful interference to radio or television reception, which can be determined by turning the equipment off and on, the user is encouraged to try to correct the interference by one or more of the following measures:
 Reorient or relocate the receiving antenna.
 Increase the separation between the equipment and receiver.
 Connect the equipment into an outlet on a circuit different from that to which the receiver is connected. Consult the dealer or an experienced radio/TV technician for help.

2

PRODUCT INFORMATION

Illustrations on the manual are for installation purpose only. It may not be identical to the fixture purchased.

DIMMABLE
 compatible with most wall based 0-10V dimming controllers

The dimensions of Light Engines + Reflector kits as below

No.	Light Engines	Reflector Kits	Size	Light Engines Reflector Kits	Dimensions (Inch)	Cut-outs (Inch)
1		MHCD-4-HZ/WH	4"		φ 6.0"Hx5.4	φ 4.92-5.03
2	MHCD-20/25/30W-5CCT	MHCD-6-HZ/WH	6"		φ 7.49"Hx5.87	φ 6.3-7.01
3	MHCD-32/40/55W-35K	MHCD-8-HZ/WH	8"		φ 9.09"Hx6.69	φ 7.87-8.74
4		MHCD-10-HZ/WH	10"		φ 10.65"Hx7.17	φ 8.66-9.96

The dimensions of Light Engines and Reflector kits

Light Engines		
Reference Picture	Model No.	Dimensions
	MHCD-20/25/30W-5CCT	φ 4.31"Hx3.08
	MHCD-32/40/55W-35K	φ 5.53"Hx3.08

Reflector Kits		
Reference Picture	Model No.	Dimensions
	MHCD-4-HZ/WH	φ 6.0"Hx3.2
	MHCD-6-HZ/WH	φ 7.49"Hx3.68
	MHCD-8-HZ/WH	φ 9.09"Hx4.48
	MHCD-10-HZ/WH	φ 10.65"Hx4.96

3

Packing List(1PK)

For Engine			For Reflector Kits		
No.	Descriptions	Qty.	No.	Descriptions	Qty.
1	LED Engine	1	1	Reflector Kit	1
2	Installation Manual	1	2	Installation Manual	1
			3	Ceiling Cut-out Template	1

TOOLS REQUIRED (Not Included)(Cont.)

Pink Wire (Negative dimming lead)
 Violet Wire (Positive dimming lead)
 Black Wire (Hot)
 White Wire (Neutral)
 Green Wire (Ground)

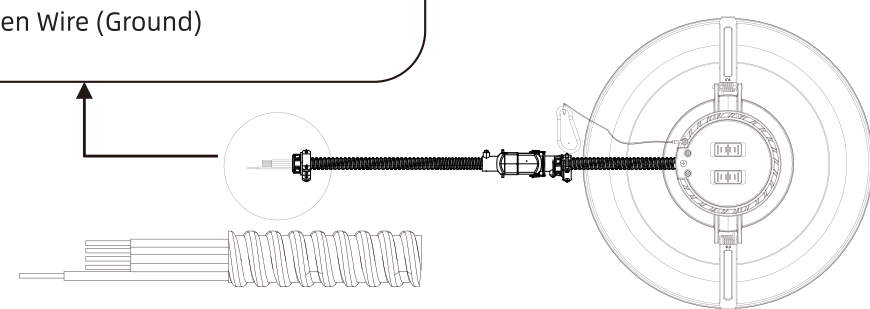

Electrical Connection Wiring:

1. Connect BLACK (line) driver lead to voltage supply Line position (HOT).
2. Connect driver WHITE lead to the NEUTRAL supply position.
3. Connect the GREEN ground lead to the supply ground lead.
- 0-10V Dimming:
 4. Connect VIOLET lead to supply POSITIVE dimming lead
 5. Connect PINK lead to the supply NEGATIVE dimming lead.
- NOT Using 0-10V Dimming:
 6. Ensure VIOLET and PINK 0-10V dimming leads are properly capped.

4

Pre-installation

First, Select the light engine what you want. The spec. of the light engines as below:

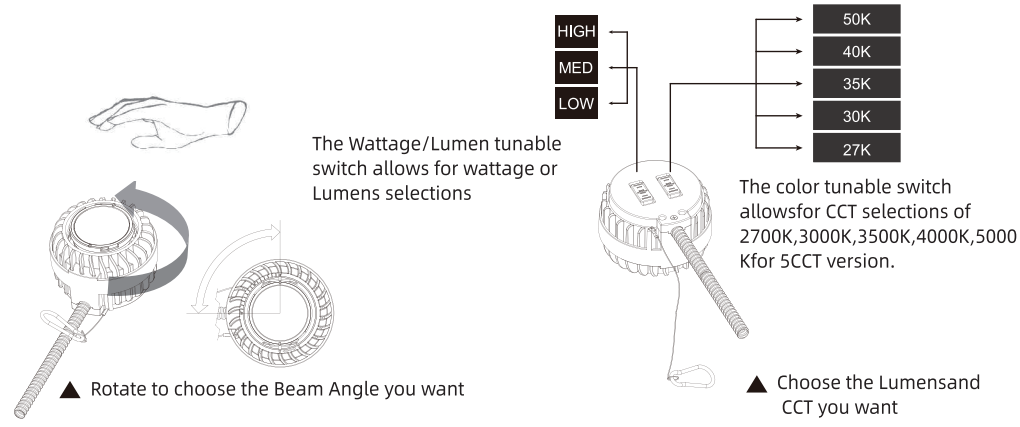

Second, Select the Reflector Kit and assemble with Light Engine.

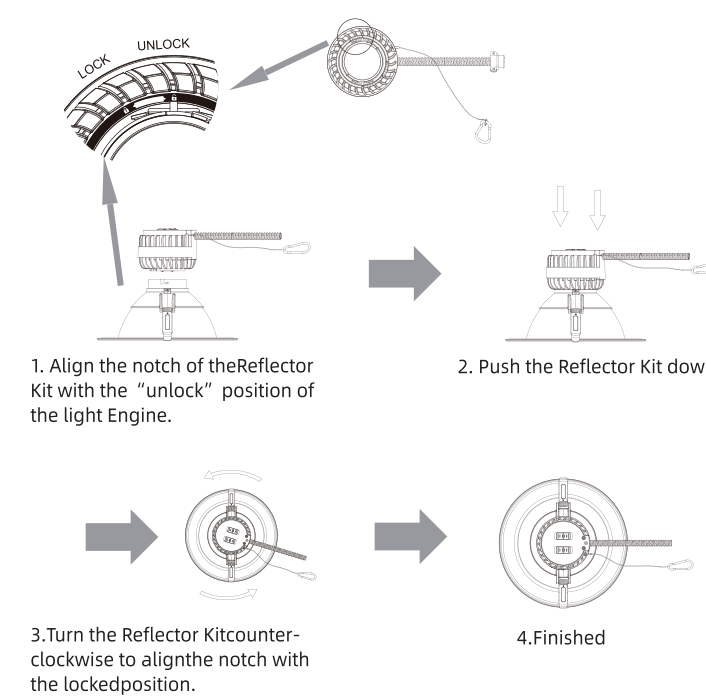

5

Pre-installation(A)

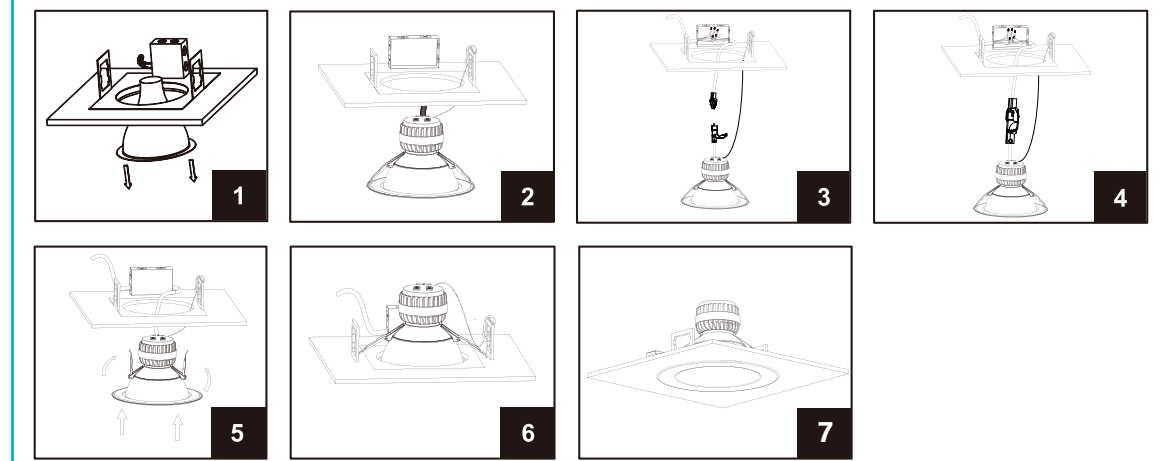

WARNING: Make sure the POWER is TURNED OFF in which you are installing the product.

1. Remove existing lamp and reflector, if existing trim or can are present, remove from the ceiling or move it out of the way. Make sure to retain existing rough-in kit components. (Figure 1)
2. Measure the ceiling opening and ensure the edge of the downlight retrofit will cover the entire hole and sit firmly in the ceiling. (Figure 2)
3. Attach the carabiner safety lanyard to the existing fixture housing. (Figure 2)
4. Remove the junction box faceplate. Disconnect wiring to existing ballast. Remove appropriate knock out on junction box.
5. Disconnect the connector between the terminal and the lamp. Connect incoming AC mains power to fixture input leads. Insert the downlight conduit into the J-box and wire to the power source (black to hot, white to neutral, violet to 0-10V dimming positive, gray to 0-10V dimming negative). Reattach the J-box cover when done. (The grounding of the overall system shall be done in accordance with NEC and local codes). Reconnect the connector and check that the light is working properly. (Figure 3&4)
6. Bend the spring clips upward so they are in an upright and insert downlight into hole in the ceiling / housing. (Figure 5)
7. Once downlight is inside the ceiling and housing, release the spring clips and push the fixture up into the ceiling until securely fixed and flush with the ceiling (rotating the downlight may be necessary to properly engage the spring clips and ensure a secure fit). (Figure 6)
8. Restore power at the source. The installation is complete. (Figure 7)

6

New Construction Installation(B)

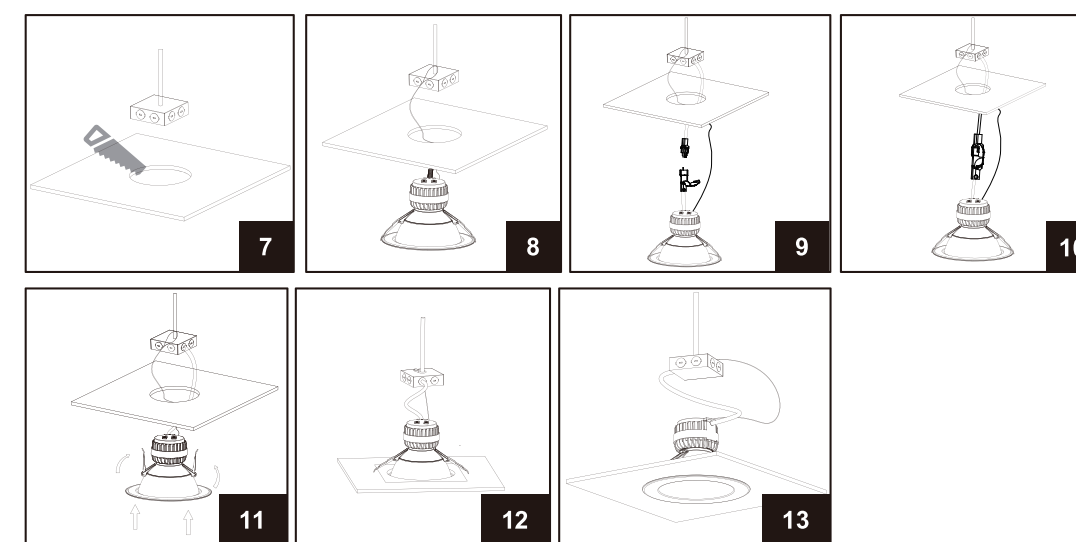

WARNING: Make sure the POWER is TURNED OFF in which you are installing the product.

1. If using a new construction plate, install it in the ceiling first.
2. If a new hole is needed, cut hole according to downlight cut-out dimension or "Ceiling Cut-out Template" per model number. (Figure 7)
3. Attach the carabiner safety lanyard to secure place inside the ceiling. (Figure 8)
4. Remove the junction box faceplate. Disconnect wiring to existing ballast. Remove appropriate knock out on junction box
5. Disconnect the connector between the terminal and the lamp. Connect incoming AC mains power to fixture input leads. Insert the downlight conduit into the J-box and wire to the power source (black to hot, white to neutral, violet to 0-10V dimming positive, gray to 0-10V dimming negative). Reattach the J-box cover when done. (The grounding of the overall system shall be done in accordance with NEC and local codes). Reconnect the connector and check that the light is working properly. (Figure 9&10)
6. Bend the spring clips upward so they are in an upright and insert downlight into hole in the ceiling / housing. (Figure 11)
7. Once downlight is inside the ceiling and housing, release the spring clips and push the fixture up into the ceiling until securely fixed and flush with the ceiling (rotating the downlight may be necessary to properly engage the spring clips and ensure a secure fit). (Figure 12)
8. Restore power at the source. The installation is complete. (Figure 13)

7

New Construction Installation(B)

WARNING - RISK OF FIRE OR ELECTRIC SHOCK. INSTALL THIS KIT ONLY IN THE LUMINAIRE THAT HAS THE CONSTRUCTION FEATURES AND DIMENSIONS SHOWN IN THE PHOTOGRAPHS AND/OR DRAWINGS AND WHERE THE INPUT RATING OF THE RETROFIT KIT DOES NOT EXCEED THE INPUT RATING OF THE LUMINAIRE
 WARNING - TO PREVENT WIRING DAMAGE OR ABRASION, DO NOT EXPOSE WIRING TO EDGES OF SHEET METAL OR OTHER SHARP OBJECTS.
 THE RETROFIT KIT IS ACCEPTED AS A COMPONENT OF ALUMINAIRE WHERE THE SUITABILITY OF THE COMBINATION SHALL BE DETERMINED BY AUTHORITIES HAVING JURISDICTION. PRODUCT MUST BE INSTALLED BY A QUALIFIED ELECTRICIAN IN ACCORDANCE WITH THE APPLICABLE AND APPROPRIATE ELECTRICAL CODES. THE INSTALLATION GUIDE DOES NOT SUPERSEDE LOCAL OR NATIONAL REGULATIONS FOR ELECTRICAL INSTALLATIONS.

WARRANTY

This product is warranted for 5 years from the date of purchase. If this product does not perform to the specifications supplied on this package, send an email to us for product return and replacement. This replacement is the sole remedy available. Liability for incidental or consequential damage is expressly excluded.

8