

27.94 cm / 11 inch

21.59 cm 8.5 inch



MRHD-SM SERIES

CARE AND MAINTENANCE

Clean with non-abrasive glass cleaner and soft cloth. Do NOT use cleaner contains abrasive agents.
 - Turned off the power before attempt to maintain the luminaire.
 - Liquid spray should be applied to the cleaning cloth, do NOT sprayed liquid directly onto the fixture.

TROUBLESHOOTING

Fixture does not light.
 Possible Solution and Corrective Action:
 1. Power is off - Check fuse, circuit breaker and switch.
 2. Incorrect wire connection - Check wiring.

Circuit breaker trips when turned on.
 Possible Solution and Corrective Action:
 1. Incorrect wire connection - Check wiring.

Flickering when turned on.
 Possible Solution and Corrective Action:
 1. Dimmer not compatible - Check the updated dimmer list, replace with the recommended dimmer.
 2. Loose wiring - Check wiring.
 3. Faulty switch - Check switch.

LIST OF RECOMMENDED DIMMERS

LUTRON - DVCL-153PR-WH, CTCL-153PDH-WH, TGCL-153PH-WH, MACL-153MH-WH, P-PKG1W-WH-R
LEVITON - R62-06674-POW, R12-06672-1LW, R50-IPL06-10M
EATON - SAL06P-LA-K

*This downlight compatible with most dimmers on the market, smooth dimming to 10% of full light levels. Please visit www.mwledlighting.com for updated dimmer info.

WARRANTY

LSQLighting warrants this products to be free from defects in material and workmanship for up to five (5) years from the date of purchase at its sole discretion. Any changes or modifications and applications not expressly approved by the manufacturer could void the user's authority to operate the equipment and warranty. Please contact LSQLighting at INFO@LIGHTINGSQUARED.COM or call (404) 998 2901 for more warranty information.

5CCT LED TRIMLESS LIGHT WITH JUNCTION BOX

For 1", 2" and 3" models, mounting clip

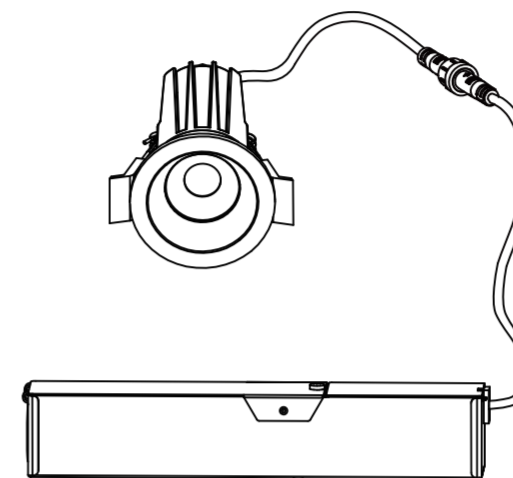

Before returning to your retailer, please call our customer service department at (404) 998 2901 if you have any questions or problems with the product.

PACKAGE CONTENTS

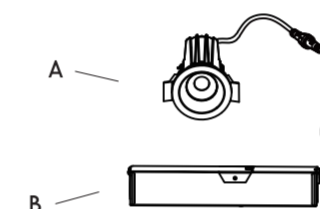

	PARTS	QT
A	Lamp with flat trim	1
B	Junction box with connector	1

SAFETY INSTRUCTION

Please read and understand all instructions before operate or install the product. Failure to do so may lead to electric shock, fire or other injuries that could be hazardous or even fatal.
 - Shut off the electricity to the wires that you are working on.
 - Do NOT open, no user serviceable parts inside. Any changes or modifications and applications not expressly approved by the manufacturer could void the user's authority to operate the equipment and warranty.

WARNING

- Risk of fire or electric shock.
- LED retrofit kit installation requires knowledge of luminaires electrical systems. Do NOT attempt installation if not qualified. Contact a qualified electrician.
- Install this kit only in the luminaires that have the construction features and dimensions shown in the photographs and/or drawings.
- Do NOT exceed the input rating of the luminaire.
- Do NOT make or alter any open holes in an enclosure of wiring or electrical components during installation.
- To prevent wiring damage or abrasion, do NOT expose wiring to edges of sheet metal or other sharp objects.
- This device is not intended for use with emergency exits.
- This luminaire has been modified to operate LED lamp. Do NOT attempt to install or operate incandescent lamps or CFL in this luminaire.
- Suitable for TYPE IC or TYPE NON-IC luminaires.
- This retrofit kit is accepted as a component of a luminaire where the suitability of the combination shall be determined by authorities having jurisdiction.

CAUTION

- Connect fixture to a 120 Volt, 60Hz power source only. Any other connection void the warranty.

This device complies with Part 15 of the FCC Rules. Operation is subject to the following two conditions: (1) This device may not cause harmful interference, and (2) this device must accept any interference received, including interference that may cause undesired operation. This equipment has been tested and found to comply with the limits for a Class B digital device, pursuant to part 15 of the FCC Rules. These limits are designed to provide reasonable protection against harmful interference in a residential installation. This equipment generates, uses and can radiate radio frequency energy and, if not installed and used in accordance with the instructions, may cause harmful interference to radio or television reception, which can be determined by turning the equipment off and on. The user is encouraged to try to correct the interference by one or more of the following measures:
 - Reorient or relocate the receiving antenna.
 - Increase the separation between the equipment and the receiver.
 - Connect the equipment into an outlet on a circuit different from that to which the receiver is connected.
 - Consult the dealer or an experienced radio/TV technician for help.

INSTALLATION

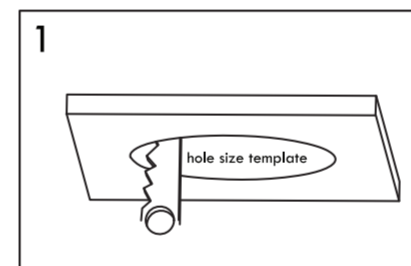

1. Use the hole size template in the packaging to cut a hole on the ceiling for installation.

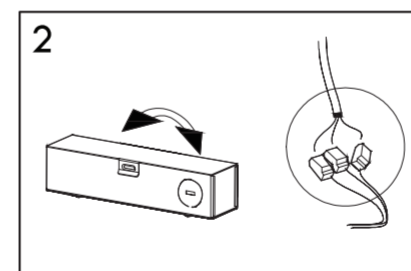

2. Remove the knockouts for wiring and open the junction box. Junction box contains three wires: hot (black), neutral (white) and bare ground. Connect the two hot wires together (one from the light switch cable and the other from the recessed housing). Repeat the step with the two neutral wires. Close the junction box to complete the wiring. ** Simple place electric cables to quick wiring connector.

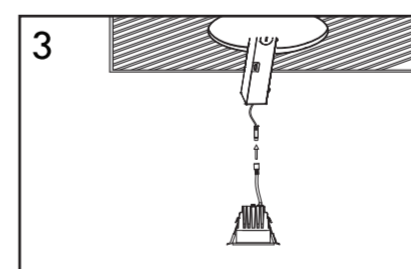

3. Connect downlight to junction box. Select your favorite color temperature by using the 5CCT switch on the junction box. Place junction box into the ceiling.

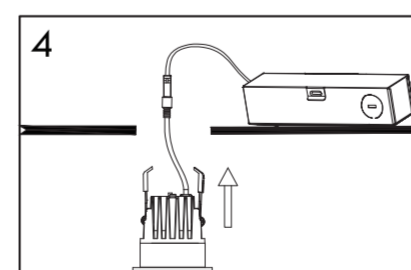

4. Push the easy mount clips up and insert the downlight into the ceiling, release clips to mount the downlight on the ceiling.

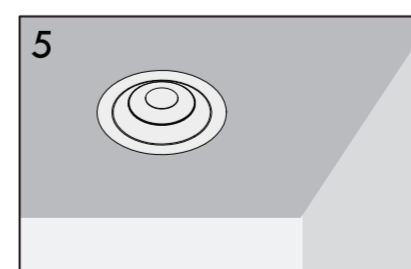

5. Secure the downlight, the installation is completed.

4

1

2

3